

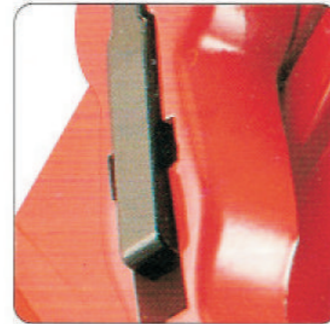

FIREMAN SWITCH

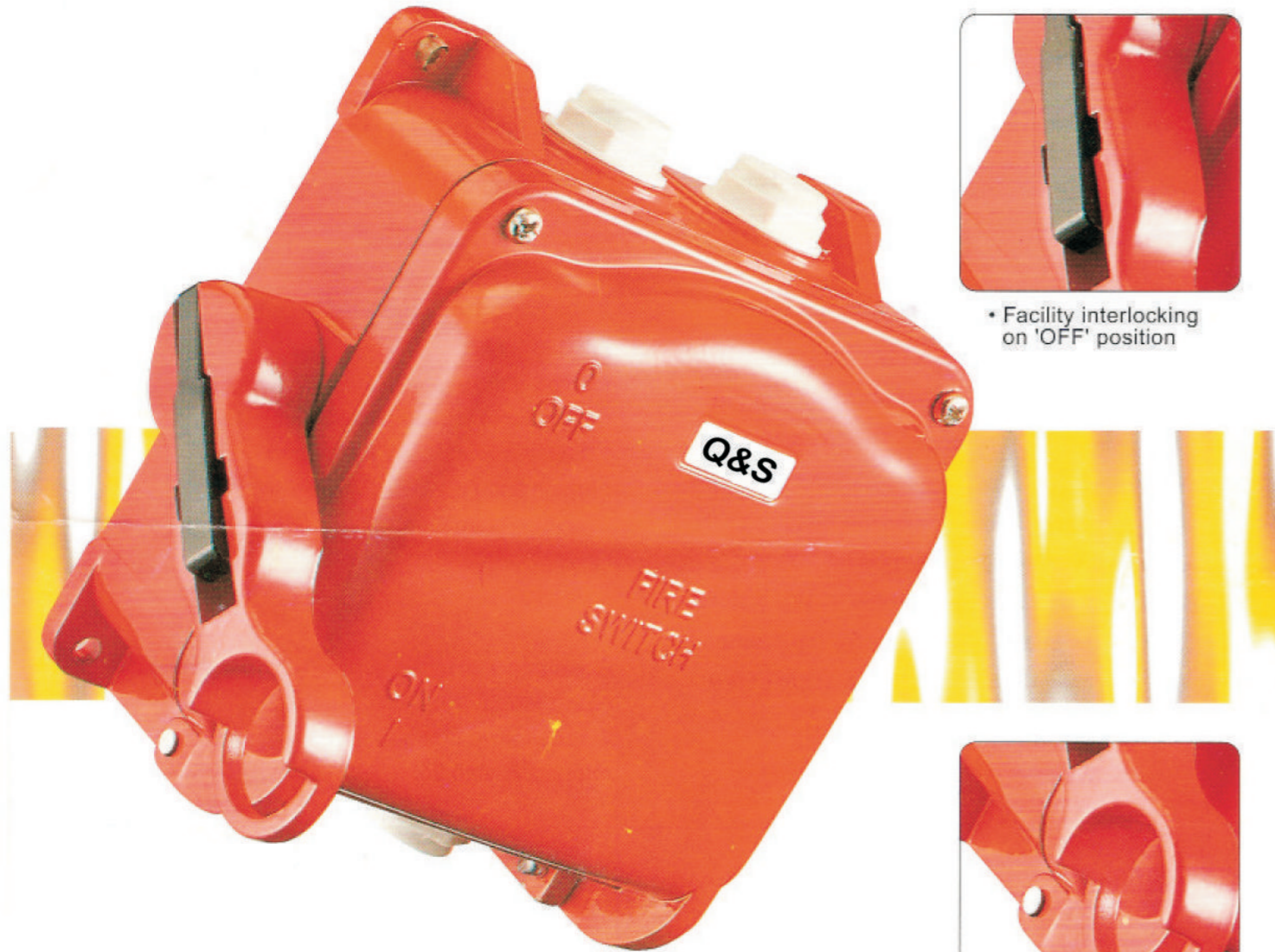

• Facility interlocking on 'OFF' position

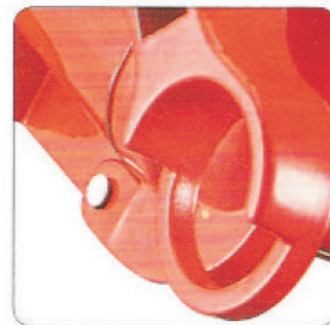

• Convenient to switch OFF by using a hooked pole through handle hole.

Weatherproof to IP65 Enclosure: Die Cast Aluminium



FIREMANSWITCH

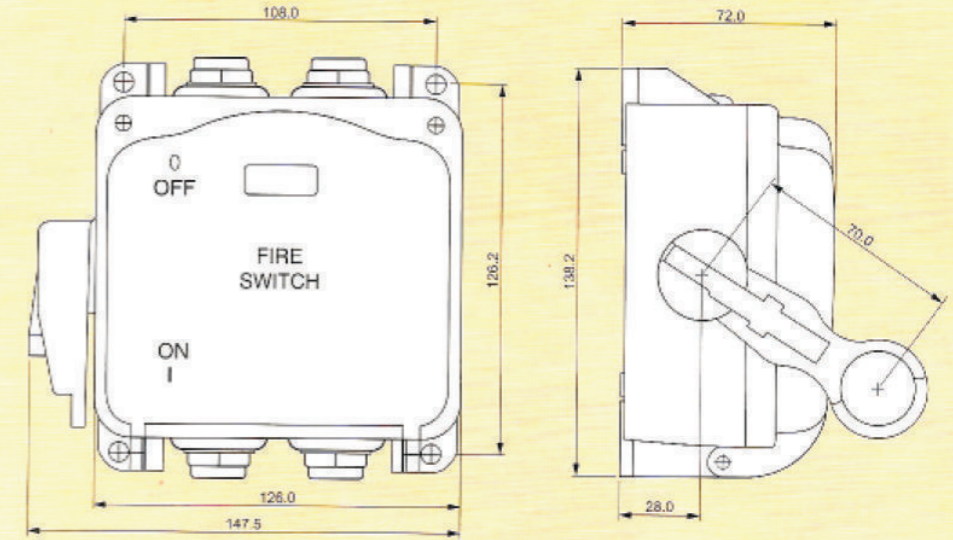

Description

- Acting as weatherproof and fire resistance isolator. It is usually connected to activate the Shunt Trip Coil connected to MCCB, ACB or other devices to disconnect the power supply to the building or factory in case of fire.
- Acting as general weatherproof Isolator installed at a location that is convenient for the fireman to switch off the power supply in the event of fire or emergency.

Technical Data

- IEC 60947-3
- Rated Voltage 240V/415Va.c. 50hz
- Utilization Category : AC23A
- Die Cast Aluminium Enclosure
- Interlocking on OFF Position
- Cover can only be opened when switch is OFF
- Ingress Protection - IP65 (IEC529)

Connection

Conductors or cable entries from top or bottom
 size 2 x M20 from top
 2 x M20 from bottom
 max cable size 25sq. mm

Type Model no.	Description	Qty/Carfon	Weight/P'cs
QFS 220	2 Poles 20 A	10 PC	0.908kg
QFS 232	2 Poles 32 A	10 PC	0.908kg
QFS 420	4Poles 20 A	10 PC	0.964kg
QFS 432	4Poles 32 A	10 PC	0.964kg



Brand: Q&S or OEM
 Phase: 3 Phase & 1 Phase
 Voltage: 415 V & 240V; or Customized
 Frequency: 50-60 Hz
 Motor power: 1-20 HP

Q&S D.O.L Magnetic Starters are in full range as below:

1HP, 3phase, 415V	1HP, 1phase, 240V
2HP, 3phase, 415V	2HP, 1phase, 240V
3HP, 3phase, 415V	3HP, 1phase, 240V
5HP, 3phase, 415V	5HP, 1phase, 240V
7.5HP, 3phase, 415V	
10HP, 3phase, 415V	
15HP, 3phase, 415V	
20HP, 3phase, 415V	

Specification:

Being one of the renowned organizations, we have been able to provide our precious clients a qualitative range of **Three Phase and Single Phase Starter Switch**. Our provided starter is manufactured by our accomplished professionals using finest quality components and ultra-modern technology. The offered is available in numerous dimensions as per the needs of our respected clients. Furthermore, this starter is highly urged and acknowledged by our patrons for its easy installation and durable finish.

Features:

1. Easy to install
2. Precise dimensions
3. Optimum finish
4. Thermal overload relay & magnetic contactor
5. Metal Box with powder coating

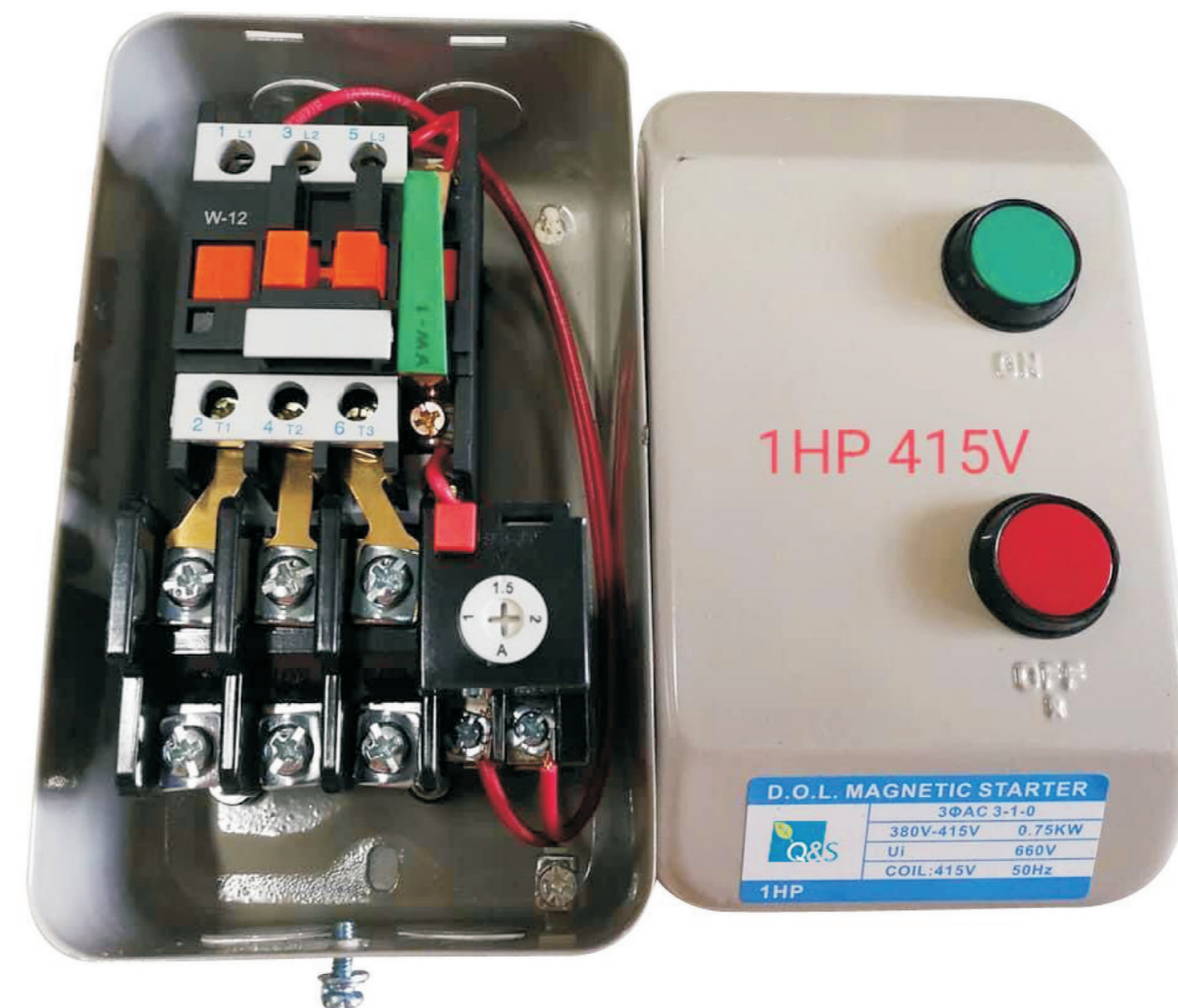



Q7 Series Magnetic Starter



CE IP55

Protection degree: IP55
High compatibility and high reliability
Convenient maintenance and repair



Quality & Service creates value

Q7 <<
Magnetic Starter

Product Structure Analysis Diagram

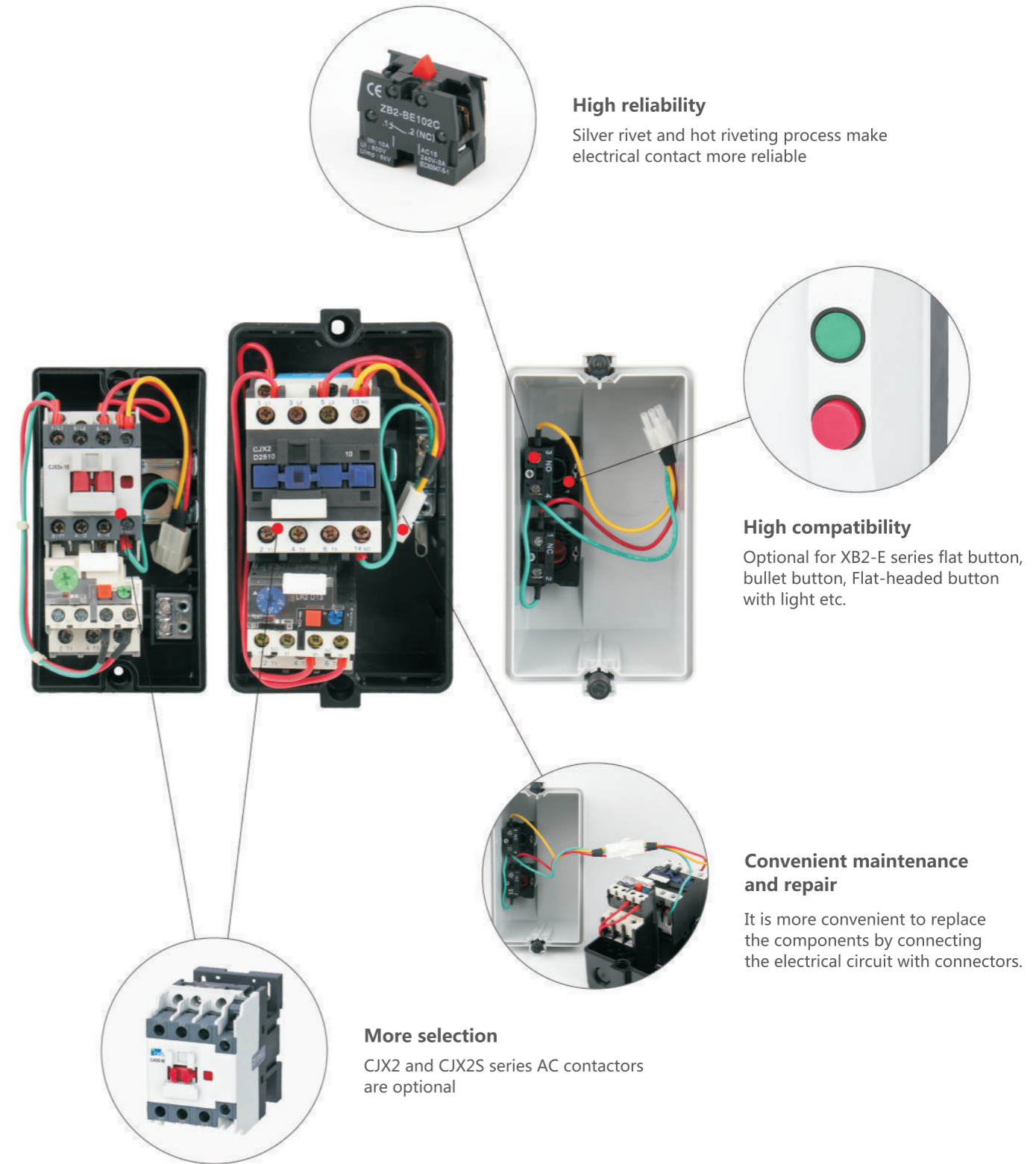

Scope of application

Q7 series magnetic starter is suitable for using in the circuits the rated voltage up to 660V, AC 50Hz or 60Hz, rated control power to 45kW and current to 95A. It is used to control the direct start and stop of the motor, and the starter with thermal overload relay protects the motor from overload and phase failure.
Standard: IEC/EN 60947-4-1.

Type Designation

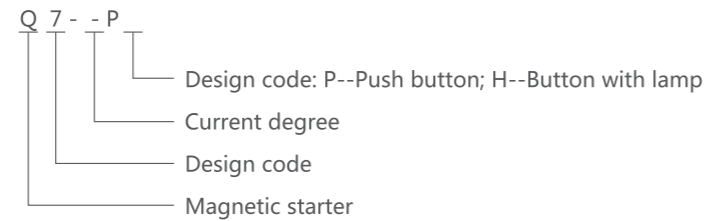

Operation and Installation Condition

Altitude:2000m
Ambient air temperature:-5°C~+40°C, average temperature of 24 hours must below+35°C
Relative humidity: the maximum temperature of 40 degrees, the air relative humidity not exceed 50%, at a lower temperature can allow for a higher relative humidity. The wettest month's average lowest temperature must be below 25°C, the max relative humidity of that month should not exceed 90%. If humidity changes as a result of occasional gel generated, should eliminate it.
Installation position: The installation degree of the tilt and vertical plane should not exceed 5°
In a non-explosive hazardous medium, and there is no place in the medium that is sufficient to corrode metals and destroy insulation gases and conductor dust. Where there is rain and snow protection and there is no steam.
Shock vibration: Products should be installed and used without severe shake, shock and vibration of the place.

Specifications

Specifications for magnetic starter (sheet1)
Coil rated control power supply voltage U_s can be divided into AC 50Hz or 60Hz: 36V, 110V, 220V, 380V.
Operating condition: Coil pull-in voltage is (85%~110%) U_s ; Release voltage is (20%~75%) U_s .



Table 1

Type	Rated current I_e A	Maximum power duty (kW)			Matched AC contactor type	Matched thermal relay	Setting current range (A)
		AC-3					
		660V	380V	220V			
Q7-09	9	5.5	4	2.2	CJX2-D09/CJX2S-09	JR28-25 JR28S-25	2.5~4, 4~6, 5.5~8
Q7-12	12	7.5	5.5	3	CJX2-D12/CJX2S-12	JR28-25 JR28S-25	7~10, 9~13
Q7-18	18	10	7.5	4	CJX2-D18/CJX2S-18		12~18
Q7-25	25	15	11	5.5	CJX2-D25/CJX2S-25		17~25
Q7-32	32	18.5	15	7.5	CJX2-D32/CJX2S-32	JR28-93 JR28S-93	23~32
Q7-40	40	18.5	18.5	11	CJX2-D40/CJX2S-40		23~32, 30~40
Q7-50	50	22	22	15	CJX2-D50/CJX2S-50		37~50, 48~65
Q7-65	65	30	30	18.5	CJX2-D65/CJX2S-65		55~70, 63~80
Q7-80	80	37	37	22	CJX2-D80/CJX2S-80		80~93
Q7-95	95	45	45	25	CJX2-D95/CJX2S-90		

Structural Features

The starter adopts a protective structure with a protective cover of IP55 and is internally composed of a CJX2 AC contactor and a JR28 thermal overload relay. The entry and exit wiring of the starter adopts the knockout type wiring hole, and the user can selectively knock and connect the four knockout holes according to the wiring requirements. The cover and the base of the starter can be completely separated, and the user is very convenient to install and maintain; the button adopts the XB2 series push button switch assembly to realize the start and stop of the starter, and it will be safe and reliable.
In order to improve the protective performance of the starter, the starter must be installed vertically. The mounting screws should be selected according to the size of the mounting hole. The screws should be no less than M5, and spring washers, flat washers and sealing rubber rings should be added to ensure the fastening of the starter. In addition, the knockout terminal holes should be equipped with corresponding waterproof terminals.

Overall and Mounting Dimensions

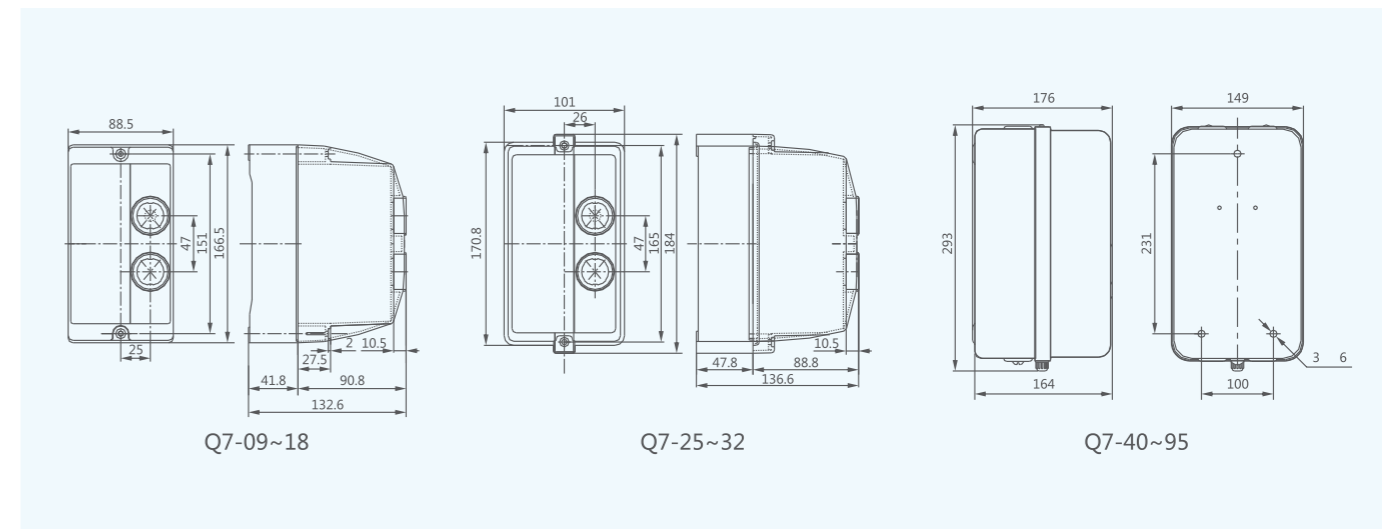

NEW PRODUCT

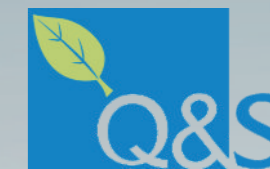

► **3 Advantages**
of CjX2S Series Contactor



**More auxiliary contacts,
meet various application requirements**

9-95A with 1NO+1NC auxiliary contact,
help customer to optimize inventory



**Suitable for larger voltage fluctuation to
ensure the stable operation of the equipment**

Suit for 70%--120% voltage range, effectively avoid
the impact of power grid voltage fluctuations, can operate
smoothly under peak electricity.



**Super environment adaptability, can be
reliable operation with extreme environment.**

The ambient temperature from -35 °C to 70 °C ,
meet the application requirements of
all kinds of occasions.

Product Structure Analysis Diagram

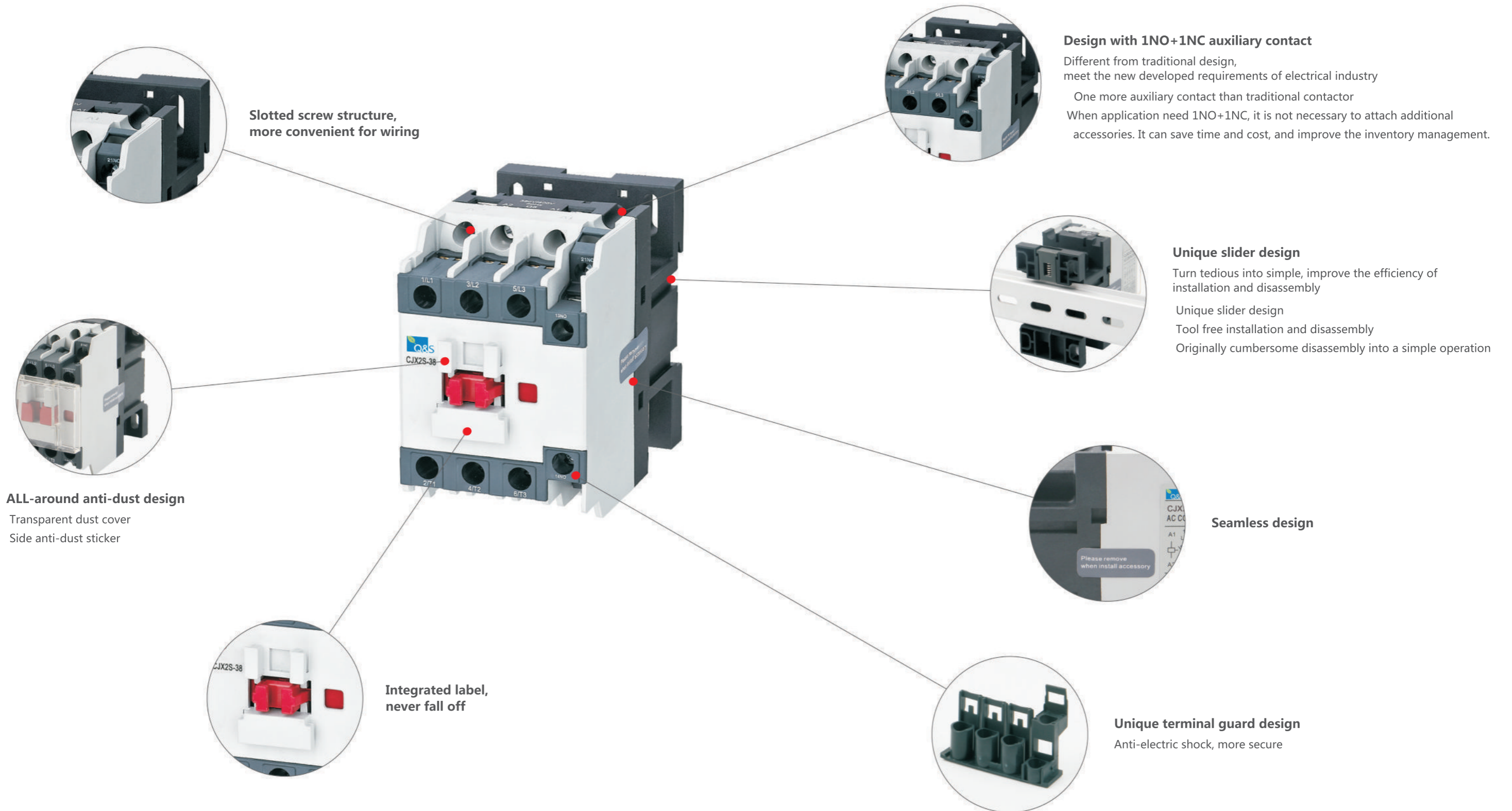

Product Overview

CJX2S series AC Contactor with novel appearance and compact structure is suitable for using starting & controlling the AC motor frequently, switching on and off the circuit at a long distance. It is used in combination with thermal relay to compose a magnetic motor starter.

Standard: IEC 60947-1, IEC 60947-4-1.



Specifications

- Rated operation current(Ie): 9-95A
- Rated operation voltage(Ue): 220V~690V
- Rated insulation voltage: 690V
- Poles: 3P
- Installation: Din rail and screw installation

Operating and Installation Conditions

Type	Operating and Installation Conditions
Installation category	III
Pollution level	3
Certification	CE, CB, CCC, TUV
Protection degree	CJX2S-09~38 IP20 CJX2S-40~95 IP10
Ambient temperature	limit of temperature: -35°C~+70°C, normal temperature: -5°C~+40°C The average no more than +35°C within 24 hours. If not in normal operating temperature range, please refer to "Instructions for abnormal environment"
Altitude	2000m
Ambient temperature	The maximum temperature of 70 degrees, the air relative humidity not exceed 50%, under lower temperature can allow for higher relative humidity. If the temperature is 20°C, the air relative humidity could up to 90%, Special measures should be taken for occasional condensation due to humidity changes.
Installation position	Inclination between installation surface and vertical surface should not exceed ±5°
Shock vibration	Products should be installed and used without significant shake, shock and vibration place.

Specifications

CJX2S Specifications



Type	CJX2S-09 CJX2S-12 CJX2S-18 CJX2S-25 CJX2S-32 CJX2S-38 CJX2S-40 CJX2S-50 CJX2S-65 CJX2S-80 CJX2S-95												
Main circuit characteristic													
Poles	3P												
Rated insulation voltage(Ui)	V	690											
Rated operating voltage(Ue)	V	380/400, 660/690											
Rated thermal current(Ith)	AC-1	20	20	32	40	50	50	60	80	80	125	125	
Rated operation current(Ie)	AC-3,380/400V	A	9	12	18	25	32	38	40	50	65	80	95
	AC-3,660/690V	A	6.6	8.9	12	18	22	22	34	39	42	49	49
	AC-3,380/400V	A	3.5	5	7.7	8.5	12	14	18.5	24	28	37	44
	AC-3,660/690V	A	1.5	2	3.8	4.4	7.5	8.9	9	12	14	17.3	21.3
Rated operational power(Pe)	AC-3,380/400V	kW	4	5.5	7.5	11	15	18.5	18.5	22	30	37	45
	AC-3,660/690V	kW	5.5	7.5	10	15	18.5	18.5	30	33	37	45	45
	AC-3,380/400V	kW	1.5	2.2	3.3	4	5.4	5.5	7.5	11	15	18.5	22
	AC-3,660/690V	kW	1.1	1.5	3	3.7	5.5	6	7.5	10	11	15	18.5
Mechanical life			1200			1000			900			650	
Electrical life	AC-3	10000 times	110			90			65			11	
	AC-4		22			17			11				
Frequency of operation	AC-3	times/hour	1200			600			300				
	AC-4		300			300							
Connecting capability of main circuit terminal													
Flexible wire	1 wire	mm ²	1...4			1.5...6			2.5...25			4...50	
No terminal	2 wire	mm ²	1...4			1.5...6			2.5...16			4...25	
Flexible wire	1 wire	mm ²	1...4			1...6			2.5...25			4...50	
With terminals	2 wire	mm ²	1...2.5			1...4			2.5...10			4...16	
Hard wire	1 wire	mm ²	1...4			1.5...6			1.5...10			2.5...25	
No terminal	2 wire	mm ²	1...4			1.5...			2.5...10			4...25	
Fastening torque		N·m	1.2			1.8			5			9	
Coil													
Rated control voltage(Us)	50Hz	V	24 36 48 110 127 220/230			240 380/400 415 440							
	50/60Hz	V	24 36 48 110 127 220/230			240 380/400 415 440							
Allowed control circuit voltage(Us)	Operation	V	Installation inclination angle ±22.5°: 85%~110%Us			Installation inclination angle±5°: 70%~120%							
	Release	V	Installation inclination angle ±22.5°: 20%~75%Us			Installation inclination angle±5°: 20%~65%							
Power consumption of coil	Actuation	VA	60			70			200			200	
	Keep	VA	6-9.5			6-9.5			15-20			15-20	
	Consumption	W	1-3			1-3			6-10			6-10	
Auxiliary contacts													
Auxiliary contacts specification	A		11										
Rated thermal current (Ith)	A		10										
Rated operating voltage (Ue)	AC	V	380										
	DC	V	220										
Rated control capacit	AC-15	VA	360										
	DC-13	W	33										
Certification			CCC, CE, TUV, CB										

Overall and Mounting

CJX2S-09~38

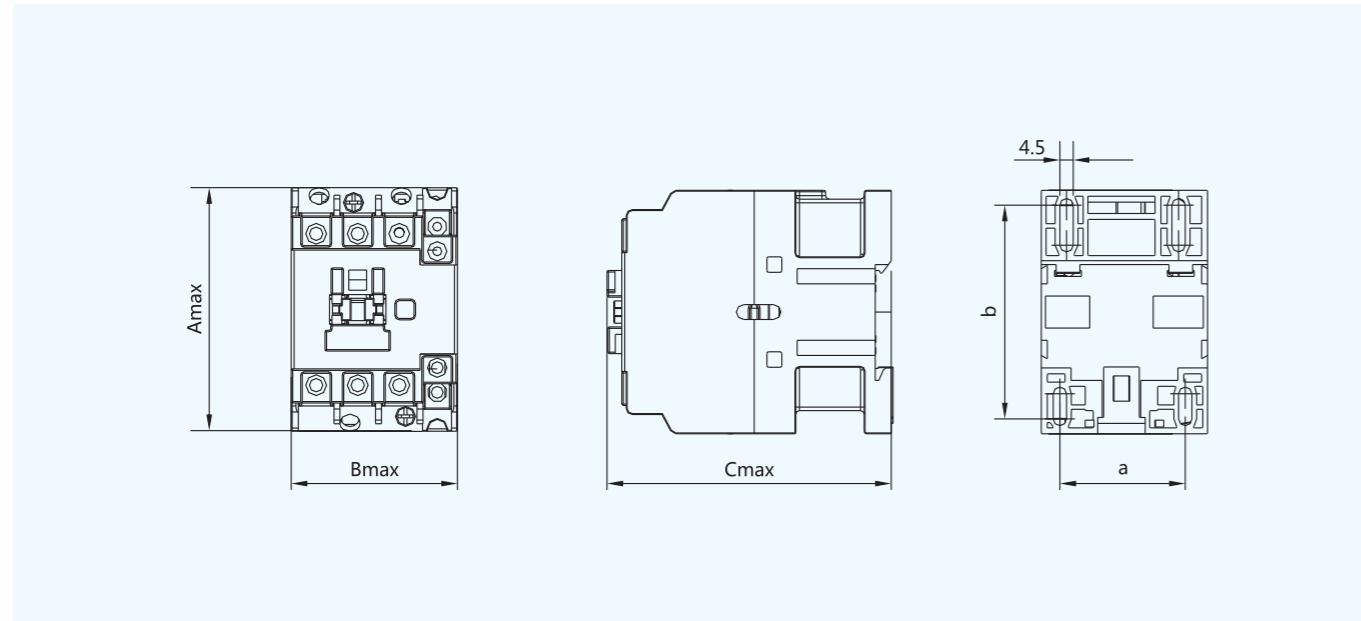

CJX2S-40~95

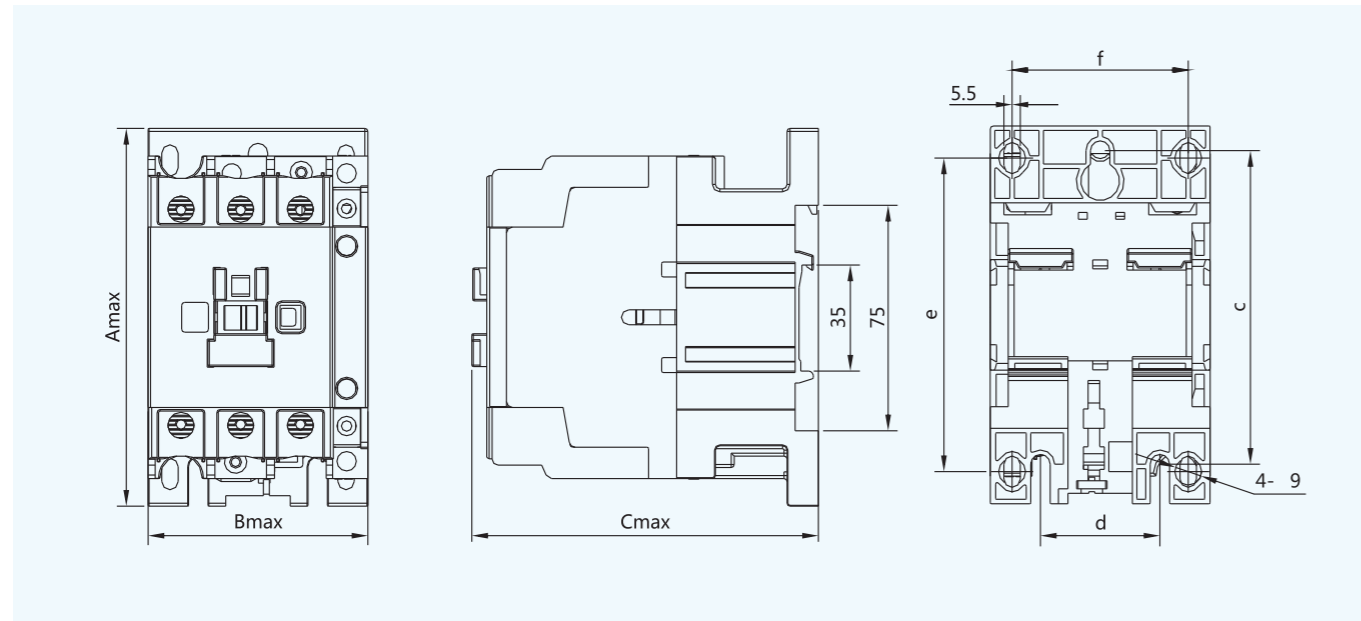

Type	Amax	Bmax	Cmax	a	b	c	d	e	f
CJX2S-09, 12, 18	74.5	45.5	85.5	35	50/60	-	-	-	-
CJX2S-25, 32, 38	83	56.5	97	40	50/70	-	-	-	-
CJX2S-40, 50, 65	127.5	74.5	117	-	-	105	40	100/110	59
CJX2S-80, 95	127.5	85.5	125.5	-	-	105	40	100/110	67

Product Overview

CJX2i series AC Contactor with novel appearance and compact structure is suitable for using starting & controlling the AC motor frequently, switching on and off the circuit at a long distance. It is used in combination with thermal relay to compose a magnetic motor starter.

Standard: IEC 60947-1, IEC 60947-4-1.

Specifications

- Rated operation current(Ie): 9-95A ;
- Rated operation voltage(Ue): 220V~690V ;
- Rated insulation voltage: 690V ;
- Poles: 3P ;
- Installation: Din rail and screw installation

Operating and Installation Conditions

Type	Operating and Installation Conditions
Installation category	III
Pollution level	3
Certification	CE, CB, CCC, TUV
Protection degree	CJX2i-09~38: IP20; CJX2i-40~95: IP10
Ambient temperature	limit of temperature: -35°C~+70°C, normal temperature: -5°C~+40°C , The average no more than +35°C within 24 hours. If not in normal operating temperature range, please refer to "Instructions for abnormal environment"
Altitude	≤2000m
Ambient temperature	The maximum temperature of 70 degrees, the air relative humidity not exceed 50%, under lower temperature can allow for higher relative humidity. If the temperature is 20°C, the air relative humidity could up to 90%, Special measures should be taken for occasional condensation due to humidity changes.
Installation position	Inclination between installation surface and vertical surface should not exceed ±5°
Shock vibration	Products should be installed and used without significant shake, shock and vibration place.



Specifications

CJX2i Specifications

Appearance														
Type	CJX2i-09 CJX2i-12 CJX2i-18 CJX2i-25 CJX2i-32 CJX2i-38 CJX2i-40 CJX2i-50 CJX2i-65 CJX2i-80 CJX2i-95													
Main circuit characteristic														
Poles	3P													
Rated insulation voltage(Ui)	V	690												
Rated operating voltage(Ue)	V	380/400, 660/690												
Rated thermal current(Ith) , AC-1		20	20	32	40	50	50	60	80	80	125	125		
Rated operation current(Ie)	AC-3,380/400V	A	9	12	18	25	32	38	40	50	65	80	95	
	AC-3,660/690V	A	6.6	8.9	12	18	22	22	34	39	42	49	49	
	AC-4,380/400V	A	3.5	5	7.7	8.5	12	14	18.5	24	28	37	44	
	AC-4,660/690V	A	1.5	2	3.8	4.4	7.5	8.9	9	12	14	17.3	21.3	
Rated operational power(Pe)	AC-3,380/400V	kW	4	5.5	7.5	11	15	18.5	18.5	22	30	37	45	
	AC-3,660/690V	kW	5.5	7.5	10	15	18.5	18.5	30	33	37	45	45	
	AC-4,380/400V	kW	1.5	2.2	3.3	4	5.4	5.5	7.5	11	15	18.5	22	
	AC-4,660/690V	kW	1.1	1.5	3	3.7	5.5	6	7.5	10	11	15	18.5	
Mechanical life		1200			1000			900			650			
Electrical life	AC-3	10000 times	110			90			65					
	AC-4		22			17			11					
Frequency of operation	AC-3	times/hour	1200			600								
	AC-4		300			300								
Connecting capability of main circuit terminal														
Flexible wire	1 wire	mm ²	1...4			1.5...6			2.5...25			4...50		
	No terminal	2 wire	1...4			1.5...6			2.5...16			4...25		
Flexible wire	1 wire	mm ²	1...4			1...6			2.5...25			4...50		
	With terminals	2 wire	1...2.5			1...4			2.5...10			4...16		
Hard wire	1 wire	mm ²	1...4			1.5...6			1.5...10			2.5...25		
	No terminal	2 wire	1...4			1.5...			2.5...10			4...25		
Fastening torque	N-m	1.2			1.8			5			9			
Coil														
Rated control voltage(Us)	50Hz	V	24, 36, 48, 110, 127, 220/230, 240, 380/400, 415, 440											
	50/60Hz	V	24, 36, 48, 110, 127, 220/230, 240, 380/400, 415, 440											
Allowed control circuit voltage(Us)	Operation	V	Installation inclination angle ±22.5°: 85%~110%Us ; Installation inclination angle±5°: 70%~120%											
	Release	V	Installation inclination angle ±22.5°: 20%~75%Us ; Installation inclination angle±5°: 20%~65%											
Power consumption of coil	Actuation	VA	60			70			200			200		
	Keep	VA	6-9.5			6-9.5			15-20			15-20		
	Consumption	W	1-3			1-3			6-10			6-10		
Auxiliary contacts														
Auxiliary contacts specification	A	11												
Rated thermal current (Ith)	A	10												
Rated operating voltage (Ue)	AC	V	380											
	DC	V	220											
Rated control capacit	AC-15	VA	360											
	DC-13	W	33											
Certification	CCC, CE, TUV, CB													

Overall and Mounting

CJX2i-09~38

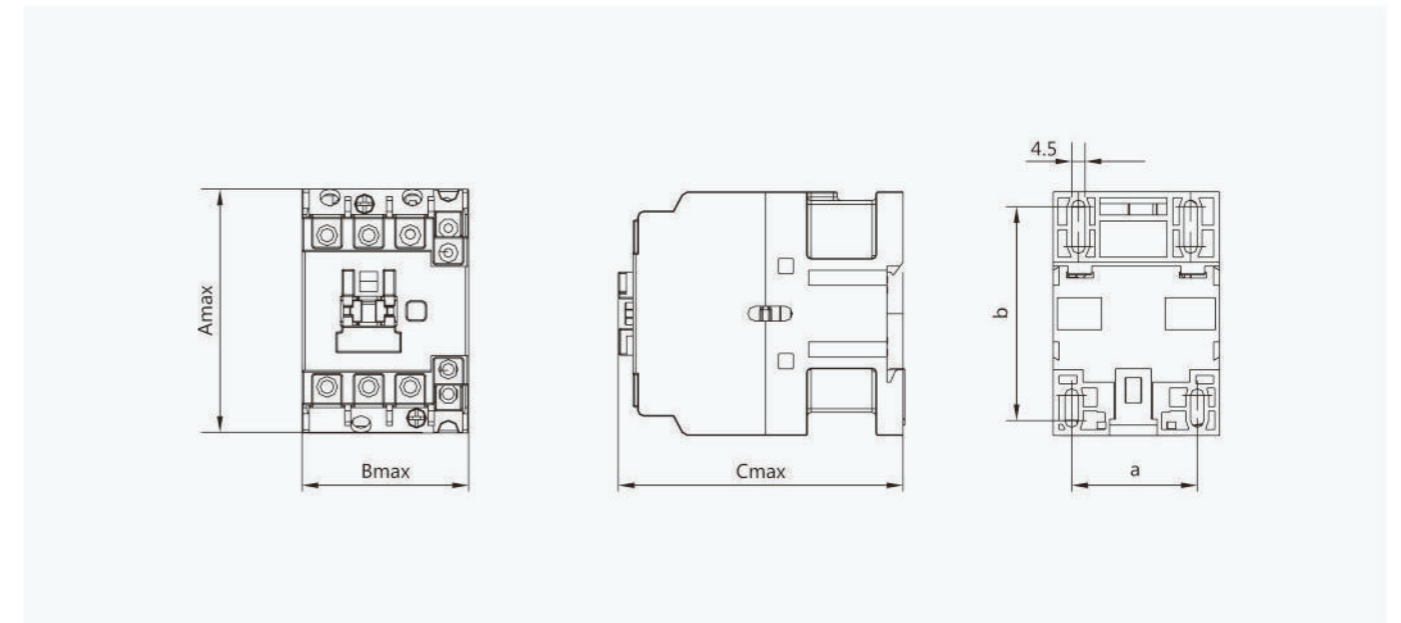

CJX2i-40~95

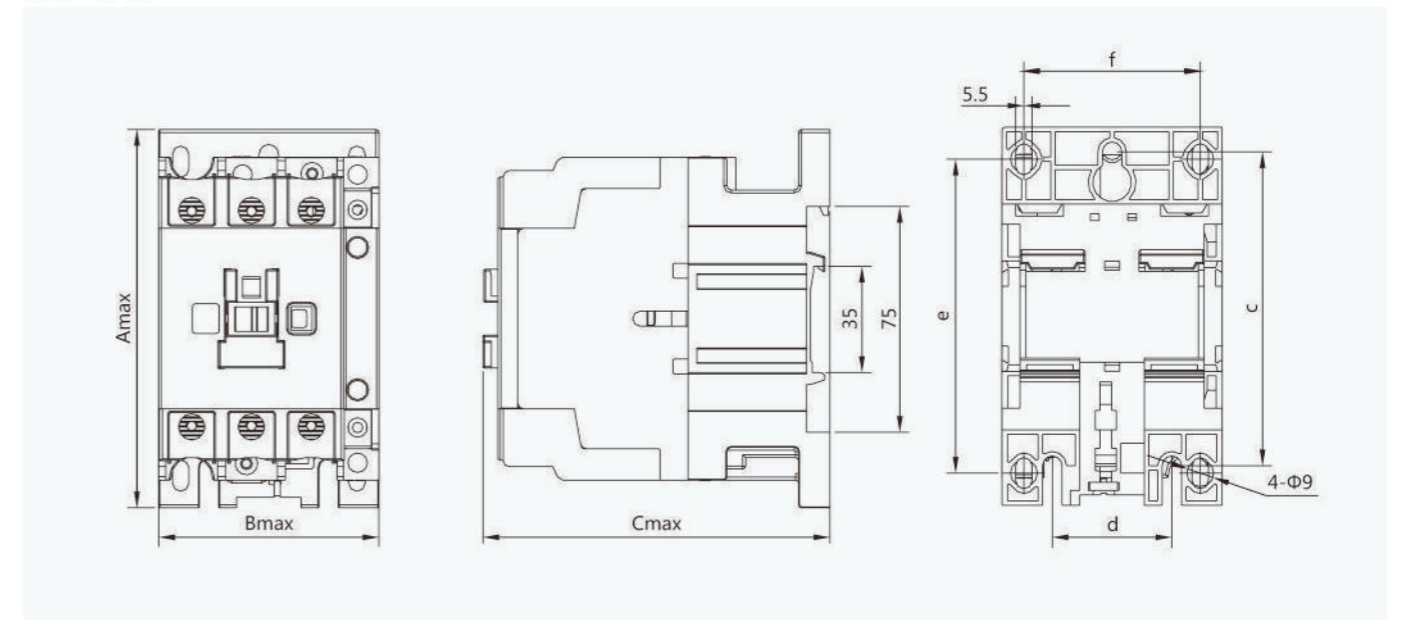

Type	Amax	Bmax	Cmax	a	b	c	d	e	f
CJX2i-09, 12, 18	74.5	45.5	85.5	35	50/60	-	-	-	-
CJX2i-25, 32, 38	83	56.5	97	40	50/70	-	-	-	-
CJX2i-40, 50, 65	127.5	74.5	117	-	-	105	40	100/110	59
CJX2i-80, 95	127.5	85.5	125.5	-	-	105	40	100/110	67

Specifications

Type	Rated operation current(Ie)(A)	Rated thermal current (Ith)(A)	Rated operational power in category AC-3 (kW)	
			380V	660V
CJX2i-09N	9	20	4	5.5
CJX2i-12N	12	20	5.5	7.5
CJX2i-18N	18	32	7.5	10
CJX2i-25N	25	40	11	15
CJX2i-32N	32	50	15	18.5
CJX2i-38N	38	50	15	18.5
CJX2i-40N	40	50	18.5	30
CJX2i-50N	50	60	22	33
CJX2i-65N	65	80	30	37
CJX2i-80N	80	95	37	45
CJX2i-95N	95	95	45	55

Outline and installation dimensions

CJX2i-09~38N

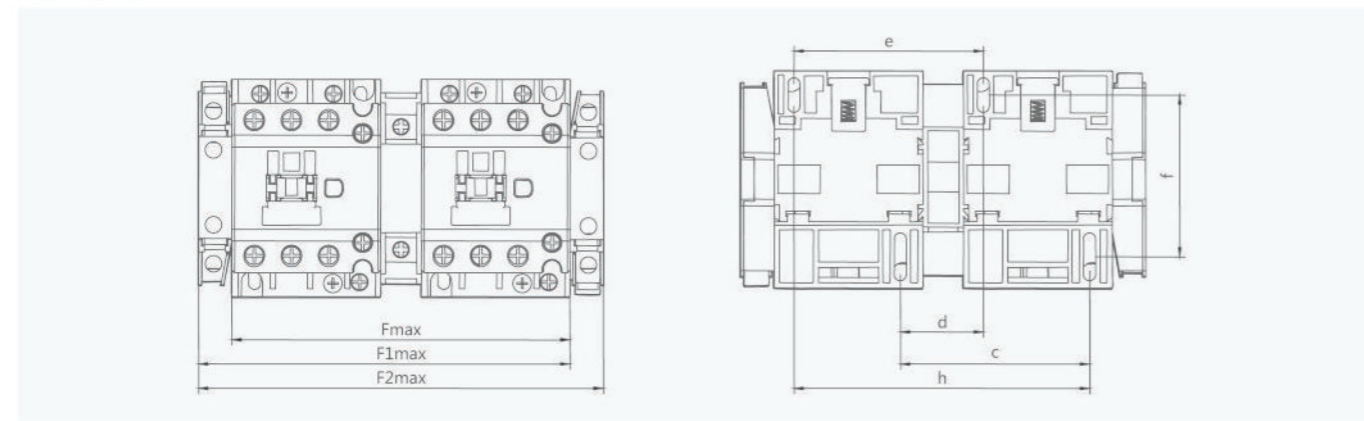

CJX2i-40~95N

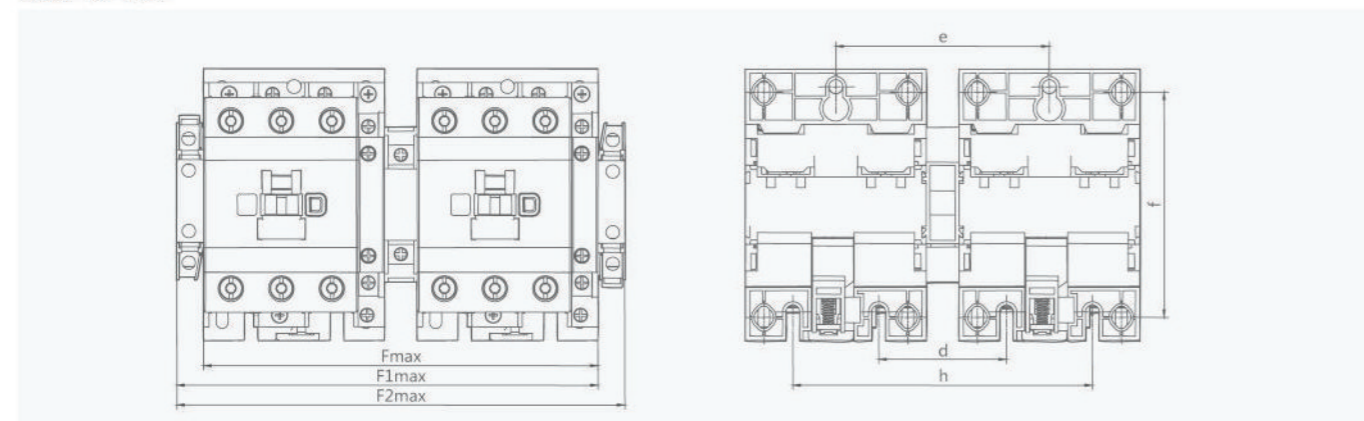

Type	Fmax	F1max	F2max	c	d	e	f	h
CJX2i-09N, 12N, 18N	107	120	131	60	25	60	50/60	95
CJX2i-25N, 32N, 38N	129	142	153	71	31.5	71	50/60	111.5
CJX2i-40N, 50N, 65N	163	180	193	-	50	90	100/110	130
CJX2i-80N, 95N	186	202	215	-	60	100	100/110	140



Description

This Resin molded current transformer is of Donut type, used for current measurement of Ac circuit rated 50/60Hz and voltage 660V and below, The product is of resin-casting type with molded fixed mounting base plate.

This resin type current transformer provides an extensive range from 50A/5A up to 5000A/5A or secondary rated at 1A as per request. It is applicable for electric cable or busbar installations. It can withstand higher temperature as compare to conventional PVC encapsulated or tape wound current transformer.

Structure feature

Current transformer is made of high quality cold-rolled oriented silicon steel, the secondary coil (rated 5A mper or 1A) is made of heavy formex copper magnet wire, then insulated with high quality resin material to obtain higher insulation level and temperature tolerance.

Technical parameter

1. System voltage: 660VAC maximum
2. Test voltage: 2.5kV r.m.s for 1 minute
3. System frequency: 50/60Hz
4. Primary rating: 50-5000A
5. Secondary output: 5A is standard
6. Short circuit thermal: 5kV for 1 sec
7. Overload withstand: 1.2 times rated currents continuously
8. rated dynamic current: 7.5kA for 2 sec
9. Insulation class IEC85, BS2757: class E
10. Operating temperature: 40°C to 85°C
11. Humidity: up to 95% RH (non condensing)
12. Enclosure: flame retardant
13. Comply with: IEC-60094-1

Applications

1. AC current measurement with AC ammeter, Demand meter, PF meter, KW meter, Kwhr meter (Sub-metering), current transducer, digital measuring instruments.
2. Applicable to general switchgear and marine switchgear installations.
3. Applicable to analog and digital types of overcurrent relays.
4. Applicable to electronic type of motor protection relays.
5. Applicable to inverter and soft starter for c.t. ratio.

Overall and mounting dimensions(mm)

Type	Primary Current	H	h	φD	φd	B	L	I	Class
iCT-32	30(60)	130	72	88	32	47	110	85	1
iCT-32	50	130	72	88	32	47	110	85	1
iCT-32	75	130	72	88	32	47	110	85	1
iCT-32	100	130	72	88	32	47	110	85	1
iCT-32	150	130	72	88	32	47	110	85	1
iCT-65	200	152	79	111	65	46	110	85	0.5
iCT-65	250	152	79	111	65	46	110	85	0.5
iCT-65	300	152	79	111	65	46	110	85	0.5
iCT-65	400	152	79	111	65	46	110	85	0.5
iCT-65	500	152	79	111	65	46	110	85	0.5
iCT-65	600	152	79	111	65	46	110	85	0.5
iCT-105	800	200	99	161	105	46	153	118	0.5
iCT-105	1000	200	99	161	105	46	153	118	0.5
iCT-125	1200	222	115	181	125	50	180	148	0.5
iCT-125	1500	222	115	181	125	50	180	148	0.5
iCT-150	1600	260	134	216	152	50	223	178	0.5
iCT-150	2000	260	134	216	152	50	223	178	0.5
iCT-150	2500	260	134	216	152	50	223	178	0.5
iCT-150	3000	260	134	216	152	50	223	178	0.5
iCT-150	4000	260	134	216	152	50	223	178	0.5
iCT-150	5000	260	134	216	152	50	223	178	0.5

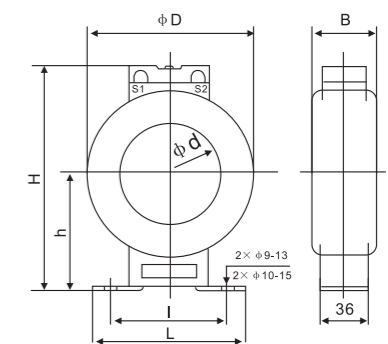

Description of Product Material

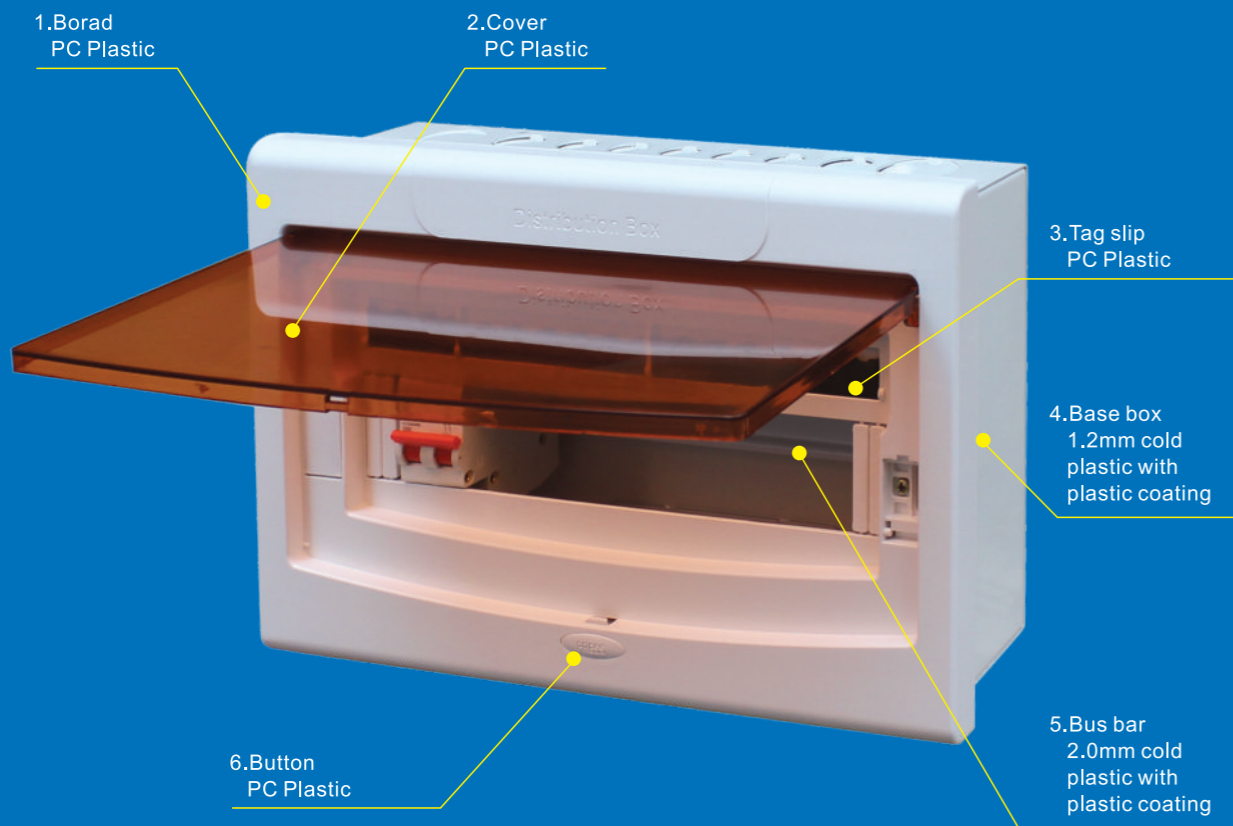

12 way



24 way



32 way

Six Innovated Functions

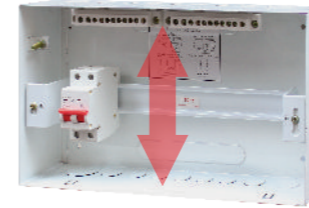

1. Large Space

Its larger space for hiding wires makes wiring inside of the box easy and keeps wires from each other at a safe distance.

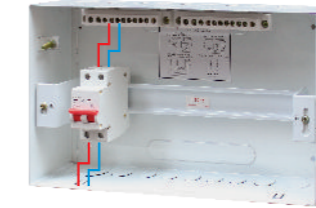

2. Easy Wiring

Movable guide rail plate can be put out of the box for wiring, unlimited by the space within the box. The panel can be adjusted to a level position with an ellipse hole in the guide rail plate, which better its appearance.



3. Easy Adjustment

Innovated function of adjustment enables the distribution box to adjust its height freely within a range from installation depth to the outside wall, which can be 20mm deep in the most. The newly added guide rail balance bar can keep solid the plate in a vertical, and installation.

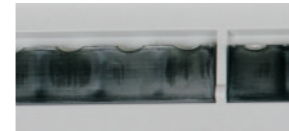

4. Easy Identification

The unique clearly-printed display circuit breaker control makes the wiring structure clear, as well as easy connection, search and maintenance.



5. Sealed Connection

Earth and N are both connected in a sealed way, which fastens and beautifies the whole structure.



6. Automatic Opening

It adopts the new function of automatic opening and closing by pressing, which is easy and convenient.

Features of distribution box

1. Material :

- Cover, button ,board, tag slip: PC plastic
- Shell of terminal bar :PC plastic
- Base box:1.2MM cold plates with plastic coating
- Busbar:2.0MM cold plates with plastic coating

2. Color:

- Green+Yellow ; White+Yellow ; Green+Gray ; White+Gray Cream+Cream White +White

3. Installation Method:

- Inside



Los **interruptores termomagnéticos** están diseñados para interrumpir la corriente eléctrica de un circuito cuando ésta sobrepasa ciertos valores máximos. El dispositivo consta de dos partes: un electroimán y una lámina bimetálica. Ambas conectadas en serie y por las que circula la corriente que va hacia la carga.

Los interruptores termomagnéticos protegen la instalación eléctrica contra sobrecorrientes (sobrecargas y cortocircuitos).

CARACTERÍSTICAS

- Posee un ancho de 3/4" de tipo enchufable. Este interruptor es compatible en tamaño con sus similares en el mercado.
- Los conductores principales están fabricados en Cobre.
- El modelado del material es Poliamida, el cual es retardante a la flama.
- Características de disparo: Curva C. Esta curva es utilizada para la protección de los circuitos (alumbrado y tomas de corriente) en aplicaciones generales.
- Corriente nominal: 10 A, 15 A, 20 A, 30 A, 40 A, 50 A y 60 A.
- Capacidad interruptiva: 10 kA.
- Desarrollado para su conexión en cables de Cobre o Aluminio del calibre 14 al calibre 4 AWG.
- Certificación: NOM ANCE
- Cuenta con indicador del estado de interrupción.
- Póliza de garantía: 2 años.

APLICACIONES

- Protección de circuitos derivados y alimentadores en instalaciones domésticas, comerciales e industriales.
- Instalación en centros de carga y tableros de alumbrado.
- Control y protección contra sobrecargas y cortocircuitos en una instalación monofásica (1 Polo).
- Protección contra sobrecargas y cortocircuitos en sistemas de distribución eléctrica de tipo domésticas, comerciales e industriales de 2 fases y 3 fases (2 Polos y 3 Polos).

INDICADOR DEL ESTADO DE INTERRUPCIÓN

Este interruptor tiene una ventana indicadora que muestra el estado de interrupción.

En **VERDE** indica que el interruptor está apagando (OFF / 0) por lo que no hay peligro para instalarlo o quitarlo del centro de carga.

En **ROJO** señala que el interruptor está encendiendo (ON / I) e indica peligro. No es recomendable instalarlo o quitarlo del centro de carga ya que el interruptor está energizado.

Cuando el interruptor se dispara **LA MIRILLA CAMBIA DEL COLOR ROJO AL VERDE**, hay que mover la palanca **OFF-ON** para restablecer la energía.

ESTRUCTURA INTERNA

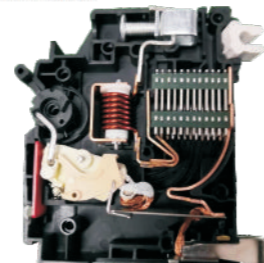

CURVA DE DISPARO

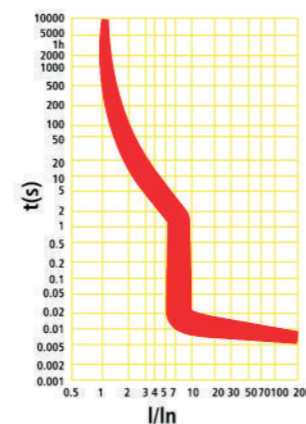

ESPECIFICACIONES TÉCNICAS			
Información general			
Normas de referencia	NMX-J-515-ANCE, NMX-J-569-ANCE y IEC/EN 60947-2		
Números de polos	1P, 2P y 3P		
Características de disparo	Curva C		
Corriente nominal In	10 A, 15 A, 20 A, 30 A, 40 A, 50 A y 60 A		
Frecuencia nominal	50/60 Hz		
Tensión nominal Ue	1 Polo: 120/240 VAC, 2 Polos: 120/240 VAC y 3 Polos: 240 VAC		
Tensión máxima de operación Umax	240 VAC		
Tensión mínima de operación	7 VAC		
Tensión nominal de aislamiento	Fase a tierra: 500 VAC Fase a fase: 500 VAC		
Capacidad nominal de cortocircuito Icn	10,000 A		
Corriente de capacidad interruptiva Icu	10,000 A		
Clase de energía limitante	3		
Categoría de sobretensión	2		
Grado de contaminación	2		
Resistencia nominal al impulso Uimp	4,000 V		
Tensión de prueba dieléctrica	1,500 V		
Tiempo de disparo a cortocircuito	5 In t≤0.1s No disparo 10 In t 0.1s Disparo		
Tiempo de disparo a sobrecarga	1.13 In, t≤1h, No disparo después le aplica 1.45 In, tiene que disparar dentro de 1h		
Temperatura de referencia para característica del disparo	30°C		
Resistencia (vida)	Mecánica: 20,000 veces		
	Eléctrica: 10,000 veces		
Datos mecánicos			
Material de la carcasa	Poliamida PA6		
Palanca	Poliamida PA66		
Indicación de posición de contacto	Marca en alternancia (ON / OFF 0)		
Grado de protección	IP20		
Resistencia al impacto	A 100 mm de altitud choca libremente el producto 10 veces con un péndulo dentro de 1 min. El producto no se puede dañar.		
Resistencia a las vibraciones	A 40 mm de altitud se cae el producto 50 veces en cada dirección (parte frontal, trasera, izquierda, derecha) y no se puede disparar.		
Condiciones ambientales	Con una temperatura máxima de 40°C la humedad relativa del aire no debe exceder del 50%. Se permite un nivel más alto de humedad relativa del aire a una temperatura más baja. Por ejemplo, en 20°C la humedad relativa puede ser del 90%.		
Temperatura ambiente	Operación: -5°C +40°C Almacenamiento: -25°C+70°C		
Material de los conductores principales (enchufable)	Cu		
Instalación			
Terminal	Lado línea: Conexión enchufable		
	Lado carga: Terminal con opresor		
Calibre de los conductores	Lado línea: Conexión enchufable		
	Lado carga: #14 - #4 AWG		
Par de apriete (torque)	31 lb in (3.5 N m)		
Posición de palanca	Apagado: OFF (0) Color de la bandera en VERDE		
	Encendido: ON (I) Color de la bandera en ROJO		
Dimensiones	1 Polo: (79×18×73) mm	2 Polos: (79×36×76.4) mm	3 Polos: (79×54×76.4) mm
Peso	1 Polo: 0.121kg	2 Polos: 0.243kg	3 Polos: 0.365kg